

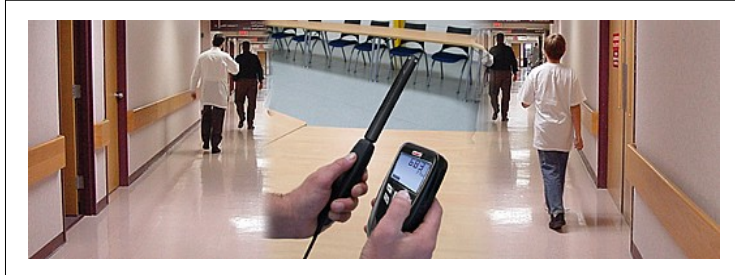

Supplied with*
Calibration certificate

Air quality AQ 100

New



Functions

- CO₂ measurement and ambient temperature
- Selection of units
- Minimum and maximum values
- HOLD function
- Adjustable automatic shut-off
- Adjustable backlight

Technical features

Measuring element.....	CO ₂ : Infrared sensor. (Non dispersive- infrared sensor NDIR)
	Ambient temperature : Pt100 class A
Display.....	2 lines, LCD technology. Sizes 50 x 34.9 mm. 1 line of 5 digits with 7 segments (value) 1 line of 5 digits with 16 segments (unit)
Housing.....	Shock-proof made of ABS, IP54 protection
Keypad.....	Metal-coated with 5 keys
Cable.....	retractable, length 450 mm, up to 2.4 m when released
Conformity.....	electromagnetical compatibility (NF EN 61326-1 guideline)
Power supply.....	1 alcaline battery 9V 6LR61
Operating temperature.....	from 0 to 50°C
Storage temperature.....	from -20 to +80°C
Auto shut-off.....	adjustable from 0 to 120 min
Weight.....	190g
Languages.....	French, english



AQ100 - CO₂ / temperature probe - Fixed

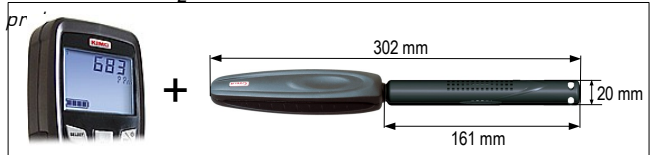

Specifications

	Measuring units	Measuring ranges	Accuracy*	Resolutions
CO₂				
	ppm	From 0 to 5000 ppm	±3 % of reading or ±50 ppm**	1 ppm
AMBIENT TEMPERATURE				
	°C, °F	From -20 to +80°C	±0.4% of reading ±0.3°C	0.1°C

*All accuracies indicated in this document were stated in laboratory conditions and can be guaranteed for measurements carried out in the same conditions, or carried out with required compensation.
 **the accuracy is expressed either by a deviation in ppm, or by a percentage of the value concerned. Only the bigger value is considered.

Working principle

NDIR - Non dispersive infrared absorbance

A gas absorbs light at a specific wavelength, some of the intensity emitted by the infrared source is absorbed by the gas sample. The amount of light read by the IR sensor is inversely proportional to CO₂ concentration.

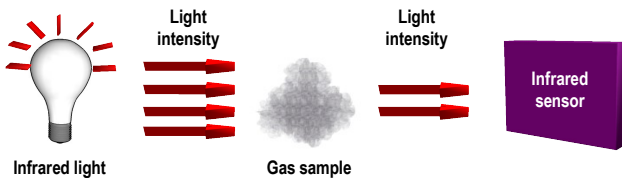

Dimensions

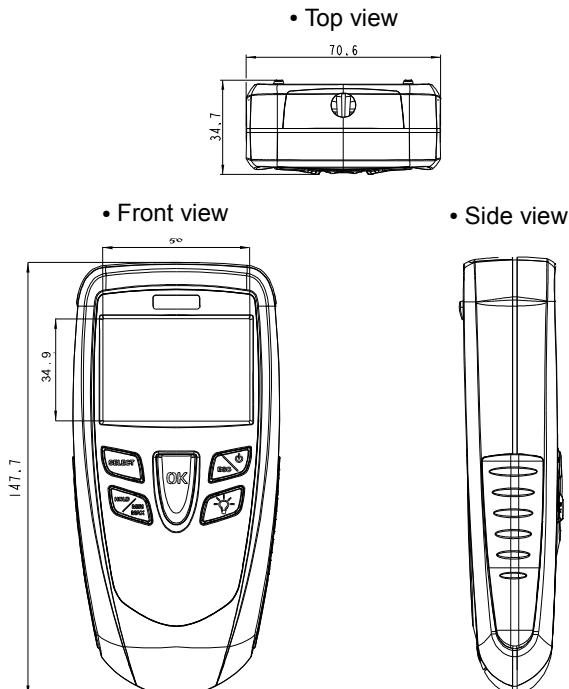

Supplied with ...



DESCRIPTION	AQ 100
Calibration certificate*	●
Transport case	●

● Included ○ Optional

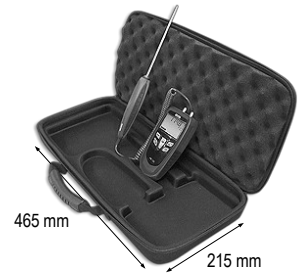
*except class 102S



Accessories (See related datasheet)

CE 100	RTS
Protective cover with magnet and holding system 	Telescopic extension (for probe), 1m long and bent 90°. 

Warranty period

Instruments have 1-year guarantee for any manufacturing defect (return to our After-Sales Service required for appraisal).

www.kimo.fr

EXPORT DEPARTMENT

Tel : + 33. 1. 60. 06. 69. 25 - Fax : + 33. 1. 60. 06. 69. 29

e-mail : export@kimo.fr



Distributed by :